



MAX1535A Evaluation Kit/ MAX1535A Evaluation System

Evaluate: MAX1535A

General Description

The MAX1535A evaluation kit (EV kit) is an efficient, multichemistry battery charger. It uses the Intel System Management Bus (SMBus™) to control the battery regulation voltage, charger current output, and input current-limit set point.

The MAX1535A EV kit can charge one, two, three, or four series Li+ cells with a current up to 8A.

The MAX1535A evaluation system (EV system) consists of a MAX1535A EV kit and the Maxim SMBUSMON board. The MAX1535A EV kit includes Windows® 95-/98-/2000-/XP-compatible software to provide a user-friendly interface.

Features

- ◆ 0.5% Battery Voltage Accuracy
- ◆ 3% Battery Charge-Current Accuracy
- ◆ Input Current-Limiting Set Point through SMBus Command
- ◆ Up to 8A Battery Charge Current
- ◆ Automatic Selection of System Power Source
- ◆ +8V to +25V Input Voltage Range
- ◆ Charges Li+, NiCd, NiMH Battery Chemistries
- ◆ SMBus-Compatible 2-Wire Serial Interface
- ◆ Includes Windows 95-/98-/2000-/XP-Compatible Software and Demo PC Board
- ◆ Fully Assembled and Tested

Ordering Information

PART	TEMP RANGE	IC PACKAGE	SMBus INTERFACE TYPE
MAX1535AEVKIT	0°C to +70°C	32 Thin QFN (5mm x 5mm)	—
MAX1535AEVSYS	0°C to +70°C	32 Thin QFN (5mm x 5mm)	SMBUSMON

Component Suppliers

SUPPLIER	PHONE	FAX	WEBSITE
AVX	843-946-0238	843-626-3123	www.avxcorp.com
Diodes Inc.	805-446-4800	805-446-4850	www.diodes.com
General Semiconductor	760-804-9258	760-804-9259	www.gensemi.com
International Resistive Co. (IRC)	361-992-7900	361-992-3377	www.irctt.com
Kemet	864-963-6300	864-963-6322	www.kemet.com
Murata	770-436-1300	770-436-3030	www.murata.com
On Semiconductor	602-244-6600	602-244-4545	www.onsemi.com
Sumida	847-545-6700	847-545-6720	www.sumida.com
Taiyo Yuden	800-348-2496	847-925-0899	www.t-yuden.com
TDK	847-803-6100	847-390-4405	www.component.tdk.com
Vishay Dale	402-564-3131	402-563-6296	www.vishay.com

Note: Please indicate you are using the MAX1535A when contacting these manufacturers.

SMBus is a trademark of Intel Corp.

Windows is a registered trademark of Microsoft Corp.



Maxim Integrated Products 1

For pricing, delivery, and ordering information, please contact Maxim/Dallas Direct! at 1-888-629-4642, or visit Maxim's website at www.maxim-ic.com.

MAX1535A Evaluation Kit/ MAX1535A Evaluation System

Evaluate: MAX1535A

Component List

DESIGNATION	QTY	DESCRIPTION
C1	1	2.2 μ F \pm 20%, 35V B-size tantalum capacitor AVX TAJB225M035 Kemet T491B225M035AS
C2	1	1 μ F \pm 10%, 25V X7R ceramic capacitor (1206) Murata GRM31MR71E105K Taiyo Yuden TMK316BJ105KL TDK C3216X7R1E105K
C3, C4, C5	3	0.01 μ F \pm 10%, 50V X7R ceramic capacitors (0603) Murata GRM188R71H103K Taiyo Yuden UMK107B103KZ TDK C1608X7R1H103K
C6, C8, C10	3	0.1 μ F \pm 10%, 25V X7R ceramic capacitors (0603) Murata GRM188R71E104K TDK C1608X7R1E104K
C7, C9	2	1 μ F \pm 10%, 16V X7R ceramic capacitors (0805) Murata GRM21BR71C105K Taiyo Yuden EMK212BJ105KG TDK C2012X7R1C105K
C11, C12, C15, C16	0	Not installed (2220)
C13, C14, C17, C18	4	22 μ F \pm 20%, 25V X5R ceramic capacitors (2220) TDK C5750X5R1E226M
C19–C22	0	Not installed (0805)
C24	1	3300pF \pm 10%, 50V X7R ceramic capacitor (0603) Murata GRM188R71H332K Taiyo Yuden UMK107B332KZ TDK C1608X7R1H332K

DESIGNATION	QTY	DESCRIPTION
D1	1	0.5A, 30V Schottky diode (SOD123) Diodes Inc. B0530W General Semiconductor MBR0530 On Semiconductor MBR0530
D2	0	Not installed
J1	1	2 x 10 right-angle female receptacle
J2	1	Smart-battery header assembly, right angle, keyless, five position
JU1, JU2, JU3	0	Not installed
L1	1	4.3 μ H, 11A, 11.4m Ω inductor Sumida CEP125-4R3MC-U
N1	1	13.5A, 30V N-channel MOSFET (SO8) Fairchild FDS6670S
P1–P8	8	-13A, -30V P-channel MOSFETs (SO8) Fairchild FDS6679Z
R1, R2	2	0.01 Ω \pm 1%, 1W sense resistors (2512) Vishay Dale WSL2512 0.010 1.0% IRC LRC-LRF2512-01-R010-F
R3	1	365k Ω \pm 1% resistor (0805)
R4	1	49.9k Ω \pm 1% resistor (0805)
R5	1	1M Ω \pm 5% resistor (0805)
R6, R7, R16–R19	0	Not installed (0603)
R8	1	20k Ω \pm 5% resistor (0603)
R9–R12	4	10k Ω \pm 5% resistors (0805)
R13	1	33 Ω \pm 5% resistor (0805)
R14, R15	0	Not installed
R20	1	5.1 Ω \pm 5% resistor (0603)
R21	1	69.8k Ω \pm 1% resistor (0603)
R22	1	49.9k Ω \pm 1% resistor (0603)
R23	1	14.7k Ω \pm 1% resistor (0603)
R24	1	100k Ω \pm 1% resistor (0603)
R25	1	10 Ω \pm 5% resistor (0603)
U1	1	MAX1535AETJ, 32-pin, 5mm x 5mm, thin QFN

MAX1535A Evaluation Kit/ MAX1535A Evaluation System

Quick Start

Recommended Equipment

- DC source to supply the input current to the charger. This source must be capable of supplying a voltage greater than the battery-voltage set point and have sufficient current rating.
- Voltmeter
- Smart battery
- Computer running Windows 95, 98, 2000, or XP
- 9-pin serial extension cable
- SMBUSMON board

Procedure

The MAX1535A EV kit is a fully assembled and tested board. Follow the steps below to verify board operation.

Do not turn on the power supply until all connections are completed. Observe all precautions on the battery manufacturer's data sheet.

- 1) Set the VPP jumper on the SMBUSMON board to VCC5.
- 2) Carefully connect the boards by aligning the 20-pin connector of the MAX1535A EV kit with the 20-pin header of the SMBUSMON board. Gently press them together.
- 3) Connect a cable from the computer's serial port to the SMBUSMON interface board. Use a straight-through 9-pin female-to-male cable.
- 4) Install the software by running the **INSTALL.EXE** program. The install program copies the files and creates icons for them in the Windows 95/98/2000/XP start menu. An uninstall program is included with the software. Click on the UNINSTALL icon to remove the EV kit software from the hard drive.
- 5) Connect power to the SMBUSMON board.
- 6) Connect the input-current supply across the ADAPTER_IN and PGND pads.
- 7) Connect a smart battery to connector J2.
- 8) Turn on the power supply.
- 9) Start the MAX1535A EV kit software.
- 10) Verify current is being delivered to the battery.

Detailed Description of Software

The MAX1535A program provides easy access to the MAX1535A registers. It is also capable of reading the registers of a smart battery and monitoring SMBus traffic.

Upon execution of the program, the software enables the MAX1535A smart-charger command panel (Figure 1),

after which any of the allowed SMBus commands can be sent to the MAX1535A. Refer to the MAX1535A data sheet for more information regarding the allowed SMBus commands.

Smart-Charger Command Panel

ChargeVoltage()

To issue the ChargeVoltage() command to the MAX1535A, enter the desired voltage, in millivolts, into the Charging Voltage edit field and select the adjacent **Write** button.

ChargeCurrent()

To issue the ChargeCurrent() command to the MAX1535A, enter the desired current, in milliamps, into the Charging Current edit field and select the adjacent **Write** button.

Auto Rewrite Checkboxes

The MAX1535A needs to receive a ChargeVoltage() or ChargeCurrent() command every 175s (typ); otherwise, the MAX1535A times out and terminates charging. Usually, a smart battery sends these necessary commands. However, when not using a smart battery with the MAX1535A EV kit, select either (or both) of the Auto Rewrite checkboxes located directly under the Charging Current and Charging Voltage edit fields. This generates a ChargeVoltage() or ChargeCurrent() command at the selected time interval located on the Timer panel.

ChargerMode()

To issue the ChargerMode() command to the MAX1535A, select a combination of checkboxes in the Charger Mode panel of commands. Each checkbox represents a bit in the ChargerMode() command word. Select the checkboxes next to the bits for which the software should write a 1, unselect the checkboxes for a 0. Send the command by selecting the **Write** button.

ChargerStatus()

Charger status is shown in the Charger Status panel. Each of the bits in the ChargerStatus() command word are shown individually with a short description of the bit.

By default, the status is automatically read once every two seconds. Disable this feature by unselecting the Active Read: Charger checkbox located on the Timer panel. Change the refresh time by entering a new value into the Timer Interval edit box and select the **Set Interval** button. When Auto Refresh is disabled, issue a ChargerStatus() command by selecting the **Read** button on the Charger Status panel.

MAX1535A Evaluation Kit/ MAX1535A Evaluation System

ChargerSpecInfo()

ChargerSpecInfo() returns the Charger Specification (0x0002) from the MAX1535A. This command is available through the *Other Bitmapped Charger Registers* panel. Select Charger Spec Info by picking it from the pulldown list located directly under the *Other Bitmapped Charger Registers* label. Issue a ChargerSpecInfo() command by selecting the **Read** button. The returned hexadecimal value is shown at the bottom of the panel.

AlarmWarning()

Alarm Warning is shown on the *Other Bitmapped Charger Registers...* panel (Figure 2). Select Alarm Warning by picking it from the pulldown list located directly under the *Other Bitmapped Charger Registers* label. Each of the bits in the AlarmWarning() command word are shown individually with a short description of the bit and a checkbox. Select the checkboxes next to the bits for which the software should write a 1; unselect the checkboxes for a 0. Send the command to the MAX1535A by selecting the **Write** button.

InputCurrent()

Input Current is shown on the *Other Bitmapped Charger Register* panel (Figure 2). Select Input Current by picking it from the pulldown list located directly under the *Other Bitmapped Charger Registers* label. Each of the bits in the InputCurrent() command word are shown individually with a short description of the bit and a checkbox. Select the checkboxes next to the bits for which the software should write a 1; unselect the checkboxes for a 0. Send the command to the MAX1535A by selecting the **Write** button.

Note: The default input-current-limit setting at POR is 256mA. All codes requesting input current greater than 11.004A result in an input-current overrange, limiting the input current to 11.004A.

ManufacturerID()

ManufacturerID() returns the Manufacturer ID (0x004D) from the MAX1535A. This command is available through the *Other Bitmapped Charger Registers* panel (Figure 2). Select Manufacturer ID by picking it from the pulldown list located directly under the *Other Bitmapped Charger Registers* label. Issue a ManufacturerID() command by selecting the **Read** button. The returned hexadecimal value is shown at the bottom of the panel.

DeviceID()

DeviceID() returns the Device ID (0x0006) from the MAX1535A. This command is available through the *Other Bitmapped Charger Registers* panel (Figure 2). Select Device ID by picking it from the pulldown list located directly under the *Other Bitmapped Charger Registers* label. Issue a DeviceID() command by selecting the **Read** button. The returned hexadecimal value is shown at the bottom of the panel.

Smart-Battery Command Panel

The software is capable of reading the registers of a smart battery. The smart battery page of the software is shown in Figure 3. The software only reads the registers selected with checkmarks. By default, the registers are automatically read once every two seconds. Disable this feature by unselecting the Active Read: Battery checkbox located on the Timer panel. Change the refresh time by entering a new value into the Timer Interval edit box and select the **Set Interval** button. When Auto Refresh is disabled, read the battery by selecting the **Refresh** button.

— Detailed Description of Hardware

The MAX1535A includes all the functions necessary to charge a smart battery. The EV kit is capable of charging with a maximum current of 8.064A and a maximum voltage of 19.2V. For more information on the operation of the MAX1535A, refer to the *Detailed Description* section of the MAX1535A data sheet.

Connecting a Smart Battery

The MAX1535A EV kit includes a 5-pin smart battery connector. To connect a smart battery to the EV kit, turn off power to the EV kit and connect the battery, making sure to correctly orient the connectors.

Evaluating the MAX1535A Above 25V

To evaluate the MAX1535A with an input voltage greater than 25V (up to 28V), capacitors C1, C2, C13, and C14 must be replaced with higher voltage-rating parts. Any capacitors that were installed in locations C11, C12, C19, and C20 must also meet the higher voltage rating.

MAX1535A Evaluation Kit/ MAX1535A Evaluation System

Evaluate: MAX1535A

MAX1535A Evaluation Kit

File Logging Interface Script Help

System Overview Generic Smart Battery (0x16) **MAX1535A Smart Charger (0x12)** SMBus Interface SMBus Scripting SMBus Traffic

Smart Charger described in file: MAX1535A.INI

Other Bitmapped Charger Registers...
0x11:R ChargerSpecInfo

0x13 ChargerStatus			0x12 ChargerMode			0x11:R ChargerSpecInfo			
(LSB)		Read	(LSB)		Write	(LSB)		Read	Write
Bit 0	CHARGE_INHIBITED	0	Bit 0	INHIBIT_CHARGE	<input type="checkbox"/>	Bit 0	CHARGER_SPEC1	?	<input type="checkbox"/>
Bit 1	MASTER_MODE	0	Bit 1	ENABLE_POLLING	<input type="checkbox"/>	Bit 1	CHARGER_SPEC2	?	<input type="checkbox"/>
Bit 2	VOLTAGE_NOTREG	1	Bit 2	POR_RESET	<input type="checkbox"/>	Bit 2	CHARGER_SPEC4	?	<input type="checkbox"/>
Bit 3	CURRENT_NOTREG	1	Bit 3	RESET_TO_ZERO	<input type="checkbox"/>	Bit 3	CHARGER_SPEC8	?	<input type="checkbox"/>
Bit 4	LEVEL_2	1	Bit 4	AC_PRESENT_MASK	<input type="checkbox"/>	Bit 4	SELECTOR_SUPPORT	?	<input type="checkbox"/>
Bit 5	LEVEL_3	0	Bit 5	Battery_Present_Mask	<input type="checkbox"/>	Bit 5	reserved	?	<input type="checkbox"/>
Bit 6	CURRENT_OR	0	Bit 6	POWER_FAIL_MASK	<input type="checkbox"/>	Bit 6	reserved	?	<input type="checkbox"/>
Bit 7	VOLTAGE_OR	0	Bit 7	reserved	<input type="checkbox"/>	Bit 7	reserved	?	<input type="checkbox"/>
Bit 8	THERMISTOR_OR	0	Bit 8	Calibration_Enable	<input type="checkbox"/>	Bit 8	reserved	?	<input type="checkbox"/>
Bit 9	THERMISTOR_COLD	0	Bit 9	reserved	<input type="checkbox"/>	Bit 9	reserved	?	<input type="checkbox"/>
Bit 10	THERMISTOR_HOT	0	Bit 10	HOT_STOP	<input type="checkbox"/>	Bit 10	reserved	?	<input type="checkbox"/>
Bit 11	THERMISTOR_UR	0	Bit 11	reserved	<input type="checkbox"/>	Bit 11	reserved	?	<input type="checkbox"/>
Bit 12	ALARM_INHIBITED	0	Bit 12	reserved	<input type="checkbox"/>	Bit 12	reserved	?	<input type="checkbox"/>
Bit 13	POWER_FAIL	1	Bit 13	reserved	<input type="checkbox"/>	Bit 13	reserved	?	<input type="checkbox"/>
Bit 14	BATTERY_PRESENT	1	Bit 14	reserved	<input type="checkbox"/>	Bit 14	reserved	?	<input type="checkbox"/>
Bit 15	AC_PRESENT	0	Bit 15	reserved	<input type="checkbox"/>	Bit 15	reserved	?	<input type="checkbox"/>
(MSB)		0x601C	(MSB)		0x????	(MSB)		0x????	

0x14 ChargingCurrent: 1000 mA Write Auto Re-Write

0x15 ChargingVoltage: 18000 mV Write Auto Re-Write

Other Numeric Charger Registers...
Read ??? Write

Data Refresh: Read (11) passed Refresh

\\\\.COM1 ready 2/10/04 5:25:09 PM [(0x12R 0x13 0x609C) Read Charger ChargerStatus 24732 0x609C VOLTAGE_NOTREG CURR

Figure 1. MAX1535A Smart-Charger Command Panel

MAX1535A Evaluation Kit/ MAX1535A Evaluation System

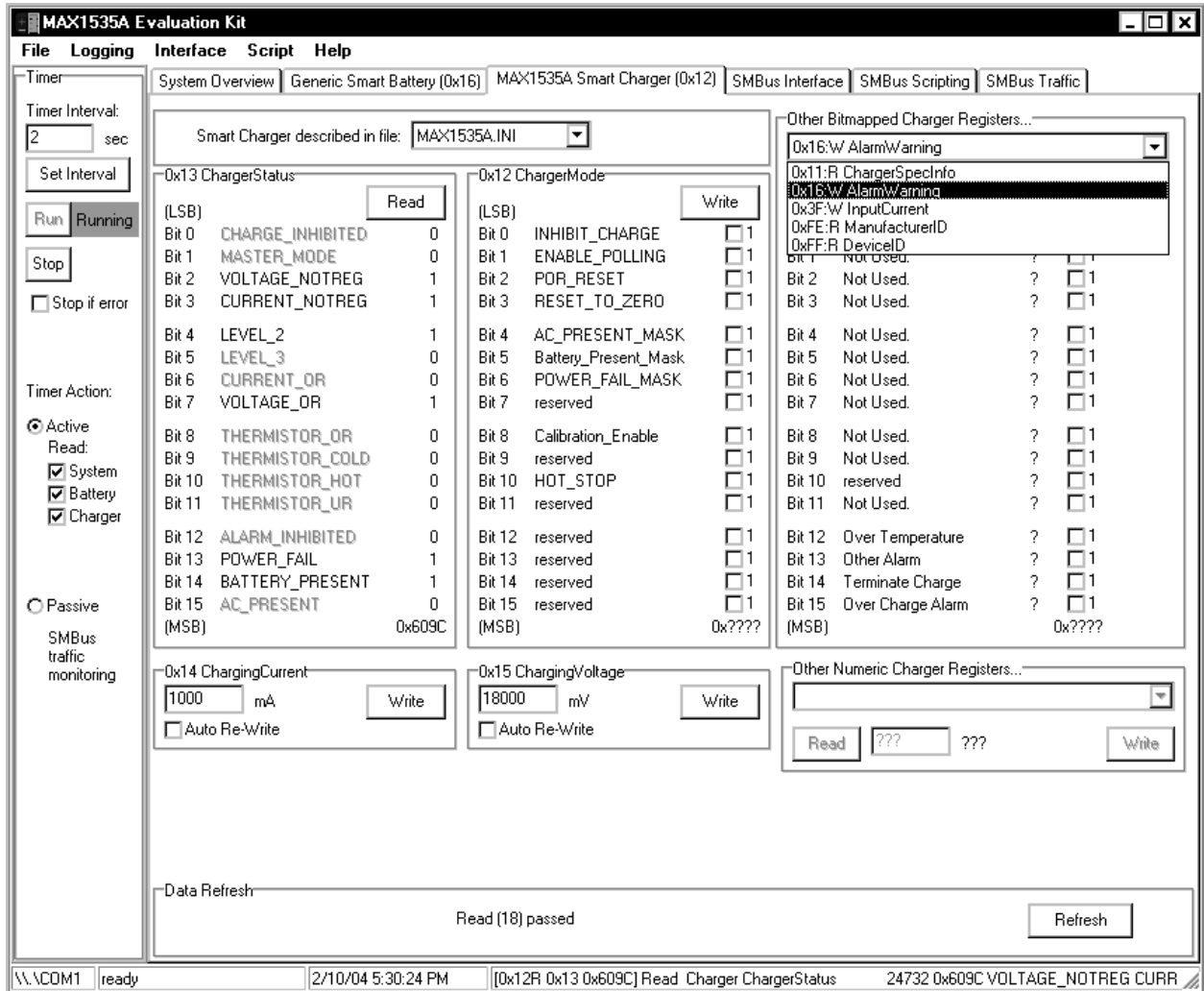

Figure 2. MAX1535A Smart-Charger Command Panel Showing the Pulldown List for Charger Spec Info, Alarm Warning, Input Current, Manufacturer ID, and Device ID

MAX1535A Evaluation Kit/ MAX1535A Evaluation System

Evaluate: MAX1535A

The screenshot shows the 'MAX1535A Evaluation Kit' software interface. The main window is titled 'MAX1535A Evaluation Kit' and has a menu bar with 'File', 'Logging', 'Interface', 'Script', and 'Help'. Below the menu bar, there are tabs for 'System Overview', 'Generic Smart Battery (0x16)', 'MAX1535A Smart Charger (0x12)', 'SMBus Interface', 'SMBus Scripting', and 'SMBus Traffic'. The 'MAX1535A Smart Charger (0x12)' tab is active, showing 'Smart Battery described in file: BATTERY.INI'.

The main area is titled 'Smart Battery Settings' and contains a grid of 23 settings, each with a checked checkbox, a label, a value field, and a unit. The settings are:

<input checked="" type="checkbox"/> 0x00 Manufacturer Access	0xFF10	<input checked="" type="checkbox"/> 0x10 Full Charge Capacity	1770 mAh
<input checked="" type="checkbox"/> 0x01 Remaining Capacity Alarm	300 mAh	<input checked="" type="checkbox"/> 0x11 Run Time to Empty	65535 minutes
<input checked="" type="checkbox"/> 0x02 Remaining Time Alarm	10 minutes	<input checked="" type="checkbox"/> 0x12 Average Time to Empty	65535 minutes
<input checked="" type="checkbox"/> 0x03 Battery Mode	0x0000 mAh	<input checked="" type="checkbox"/> 0x13 Average Time to Full	65535 minutes
<input checked="" type="checkbox"/> 0x04 At Rate	-256 mA	<input checked="" type="checkbox"/> 0x14 Charging Current	2000 mA
<input type="button" value="Apply Selected Changes (0x00..0x04 writeable)"/>			
<input checked="" type="checkbox"/> 0x05 At Rate Time to Full	65535 minutes	<input checked="" type="checkbox"/> 0x15 Charging Voltage	65471 mV
<input checked="" type="checkbox"/> 0x06 At Rate Time to Empty	402 minutes	<input checked="" type="checkbox"/> 0x16 Battery Status	0x00C0
<input checked="" type="checkbox"/> 0x07 At Rate OK	true	<input checked="" type="checkbox"/> 0x17 Cycle Count	196 cycles
<input checked="" type="checkbox"/> 0x08 Temperature	294.8 K 21.7 C	<input checked="" type="checkbox"/> 0x18 Design Capacity	3000 mAh
<input checked="" type="checkbox"/> 0x09 Voltage	16216 mV	<input checked="" type="checkbox"/> 0x19 Design Voltage	14800 mV
<input checked="" type="checkbox"/> 0x0A Current	0 mA	<input checked="" type="checkbox"/> 0x1A Specification Info	0x0010
<input checked="" type="checkbox"/> 0x0B AverageCurrent	0 mA	<input checked="" type="checkbox"/> 0x1B Manufacture Date	5/13/1999
<input checked="" type="checkbox"/> 0x0C Max Error	20 %	<input checked="" type="checkbox"/> 0x1C Serial Number	24127
<input checked="" type="checkbox"/> 0x0D Relative State of Charge	97 %	<input checked="" type="checkbox"/> 0x20 Manufacturer Name	NME
<input checked="" type="checkbox"/> 0x0E Absolute State of Charge	57 %	<input checked="" type="checkbox"/> 0x21 Device Name	42-1848
<input checked="" type="checkbox"/> 0x0F Remaining Capacity	1709 mAh	<input checked="" type="checkbox"/> 0x22 Device Chemistry	LION

At the bottom of the settings grid, there is a checkbox for '0x23 Mfg Data' with a value field containing '{ 0x42 0x44 0x59 0x4E 0x41 }'. Below this is a 'Data Refresh' section with buttons for 'Refresh', 'Select All', 'Select None', 'Erase old data' (checked), and 'Use PECs' (unchecked). There are also buttons for 'Open CSV Log...', 'Logging On', 'Logging Off', and 'Close Log'. The status bar at the bottom shows 'Read (89) passed <87 good reads>' and 'data\log.csv'.

Figure 3. Smart-Battery Command Panel

MAX1535A Evaluation Kit/ MAX1535A Evaluation System

Evaluate: MAX1535A

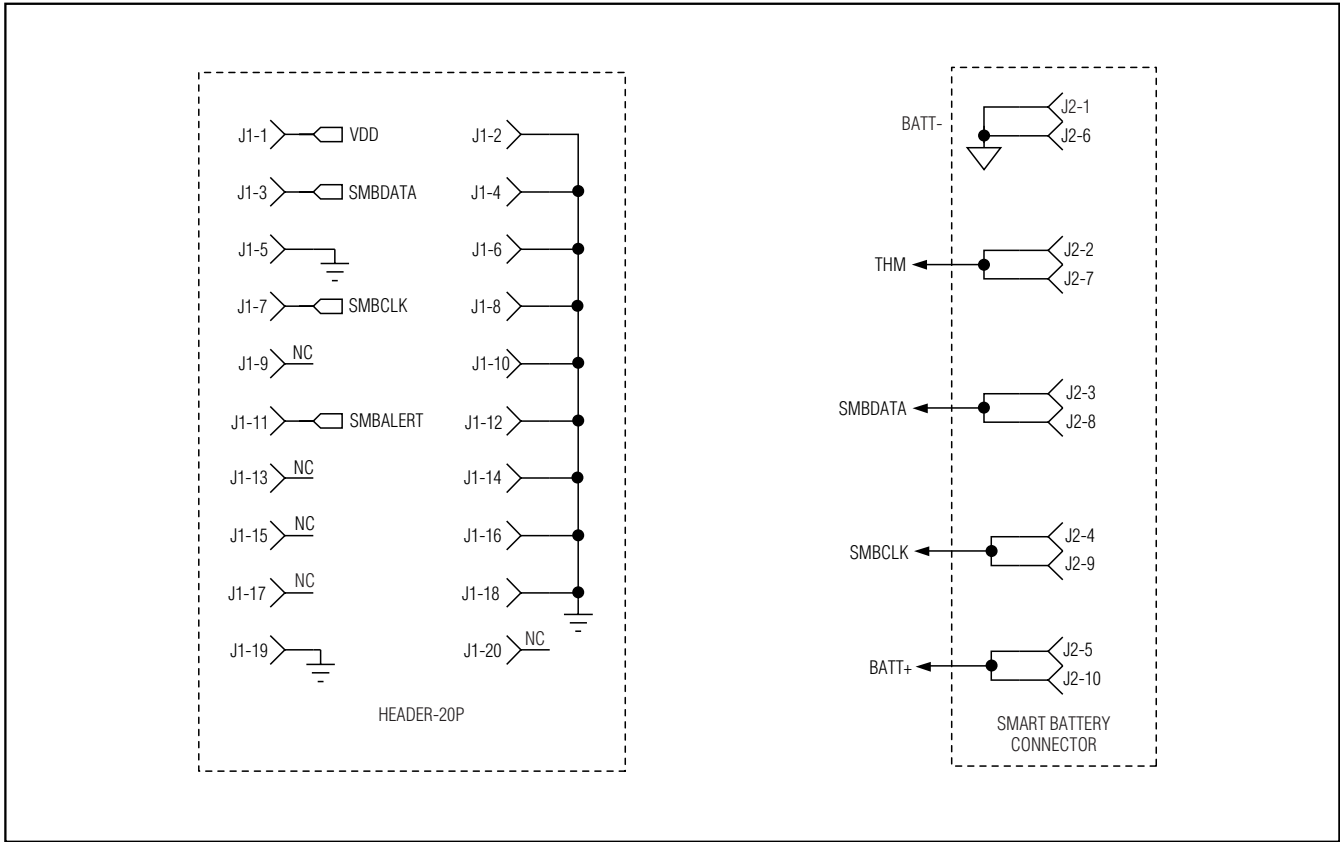

Figure 5. MAX1535A EV Kit Schematic—Smart Battery Connector

MAX1535A Evaluation Kit/ MAX1535A Evaluation System

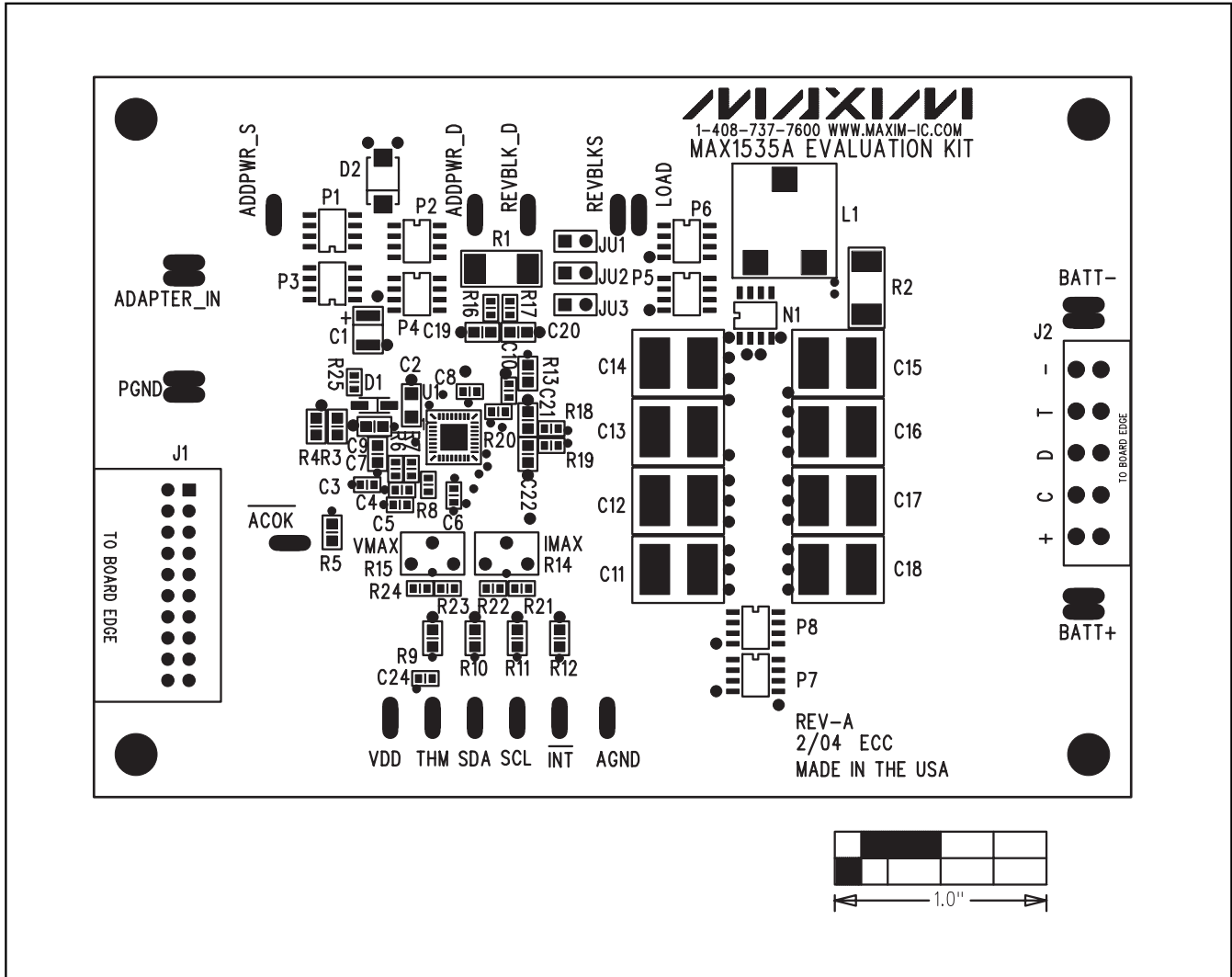

Figure 6. MAX1535A EV Kit Component Placement Guide—Component Side

MAX1535A Evaluation Kit/ MAX1535A Evaluation System

Evaluate: MAX1535A

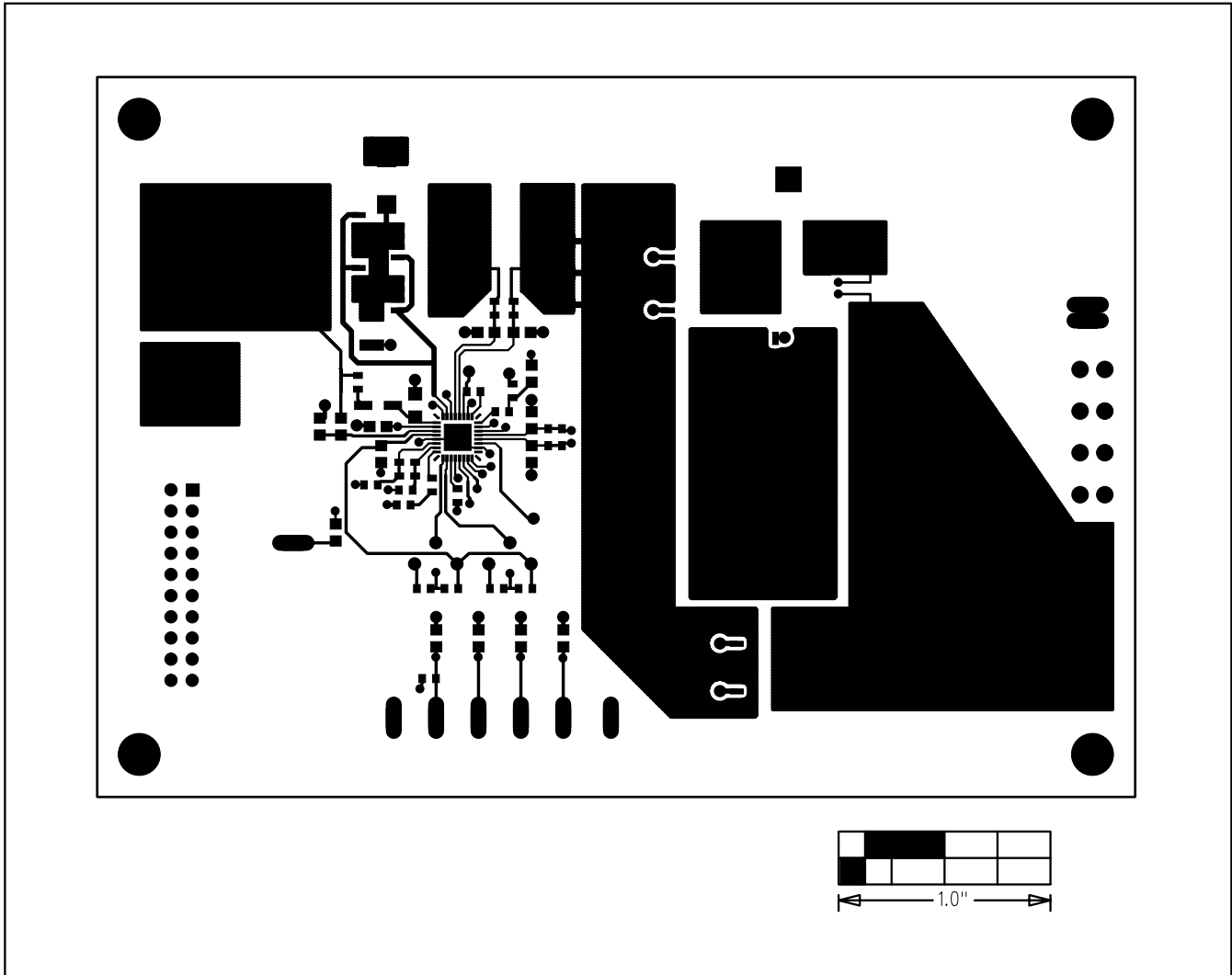

Figure 7. MAX1535A EV Kit PC Board Layout—Component Side

MAX1535A Evaluation Kit/ MAX1535A Evaluation System

Evaluate: MAX1535A

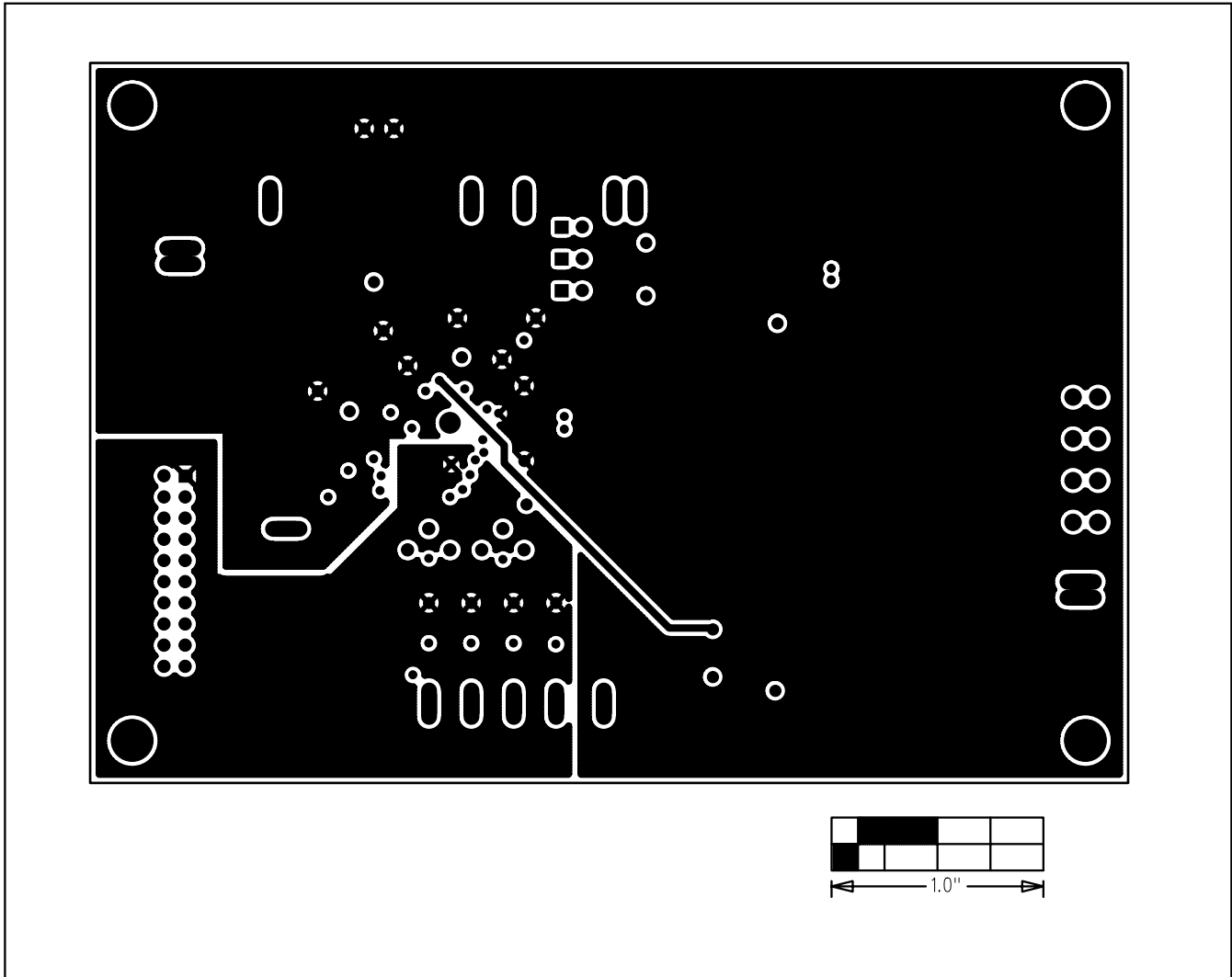

Figure 8. MAX1535A EV Kit PC Board Layout—VDD and Power Ground Plane

MAX1535A Evaluation Kit/ MAX1535A Evaluation System

Evaluate: MAX1535A

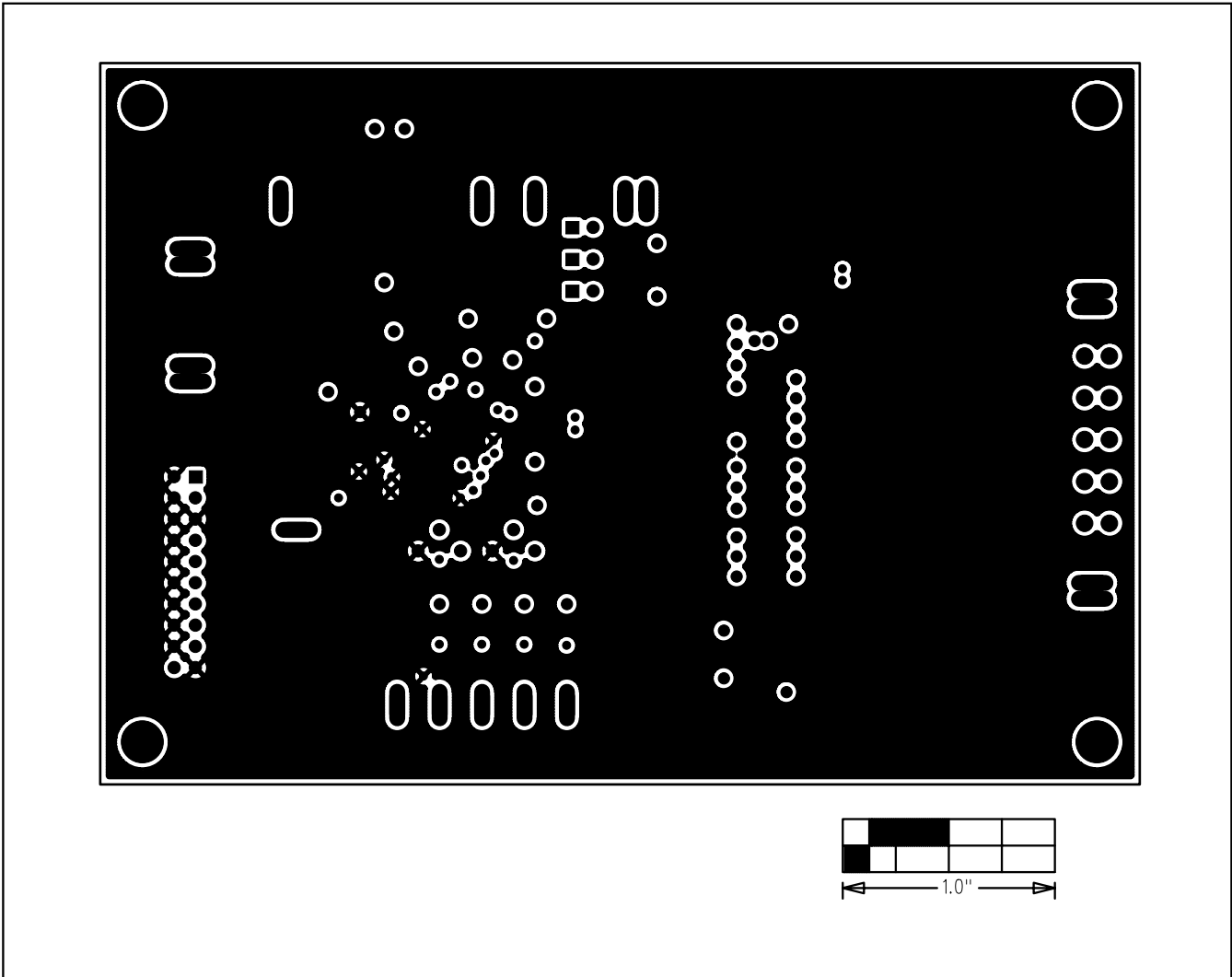

Figure 9. MAX1535A EV Kit PC Board Layout—Ground Plane

MAX1535A Evaluation Kit/ MAX1535A Evaluation System

Evaluate: MAX1535A

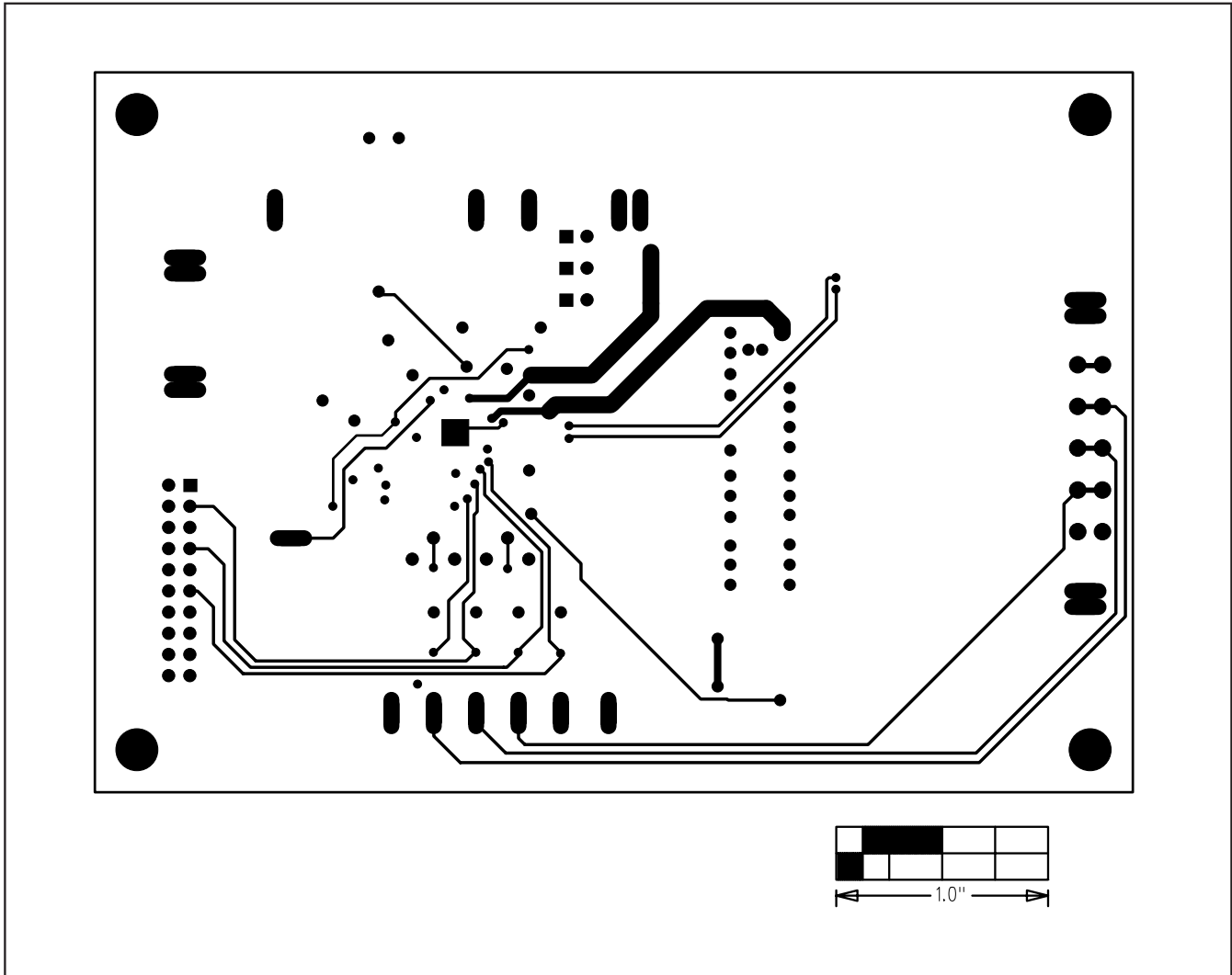

Figure 10. MAX1535A EV Kit PC Board Layout—Solder Side

Maxim cannot assume responsibility for use of any circuitry other than circuitry entirely embodied in a Maxim product. No circuit patent licenses are implied. Maxim reserves the right to change the circuitry and specifications without notice at any time.

14 **Maxim Integrated Products, 120 San Gabriel Drive, Sunnyvale, CA 94086 408-737-7600**